

TOOLS REQUIRED / OUTILS REQUIS

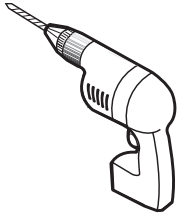

DRILL
PERCEUSE

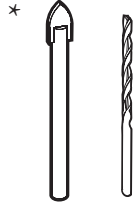

1/4" & 1/8" DRILL BITS
MÈCHE 1/4" & 1/8"

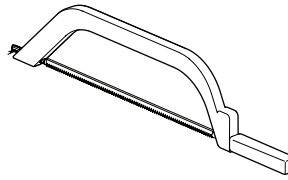

HACKSAW
SCIE À MÉTAUX

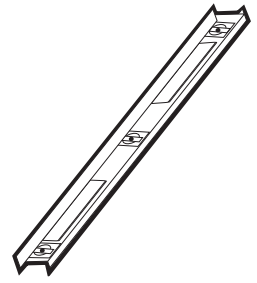

LEVEL
NIVEAU



PENCIL
CRAYON

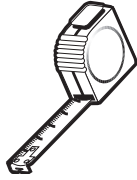

TAPE MEASURE
RUBAN À MESURER



PLIERS
PINCE



SCREWDRIVER
TOURNEVIS

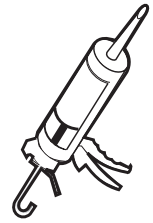

SILICONE
SCCELLANT

* Use a 1/4" drill bit for ceramic when drilling into ceramic tiles • * Utiliser une mèche à céramique de 1/4" lors du perçage des tuiles en céramique.

POSSIBLE CONFIGURATIONS / CONFIGURATIONS POSSIBLES

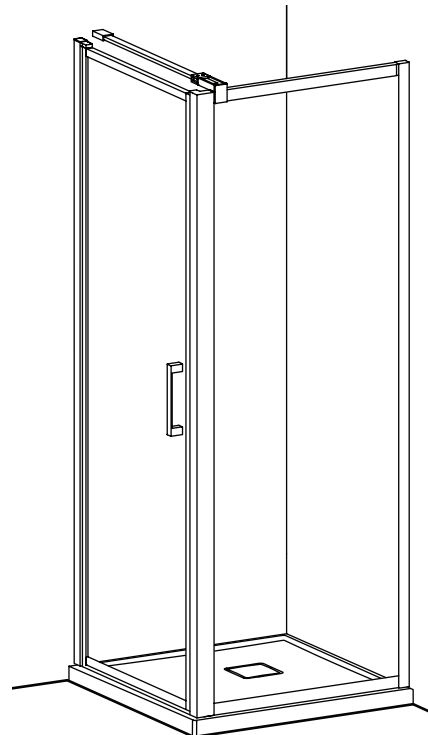
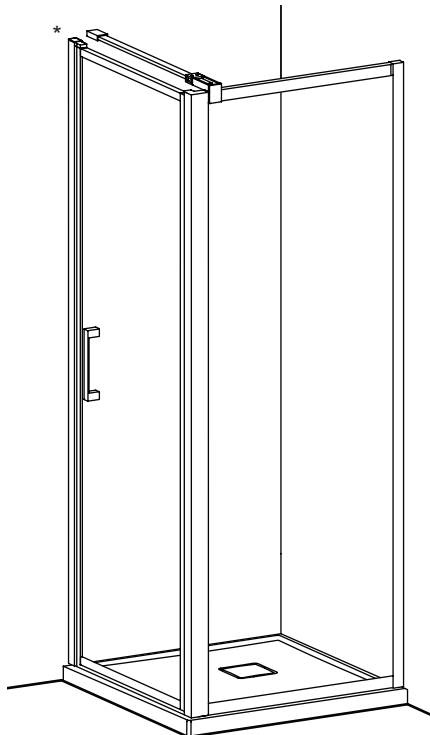

* This configuration is illustrated in this manual. • * Cette configuration est illustrée dans ce manuel.

**PARTS AND HARDWARE LISTING /
LISTE DES PIÈCES ET QUINCAILLERIE**

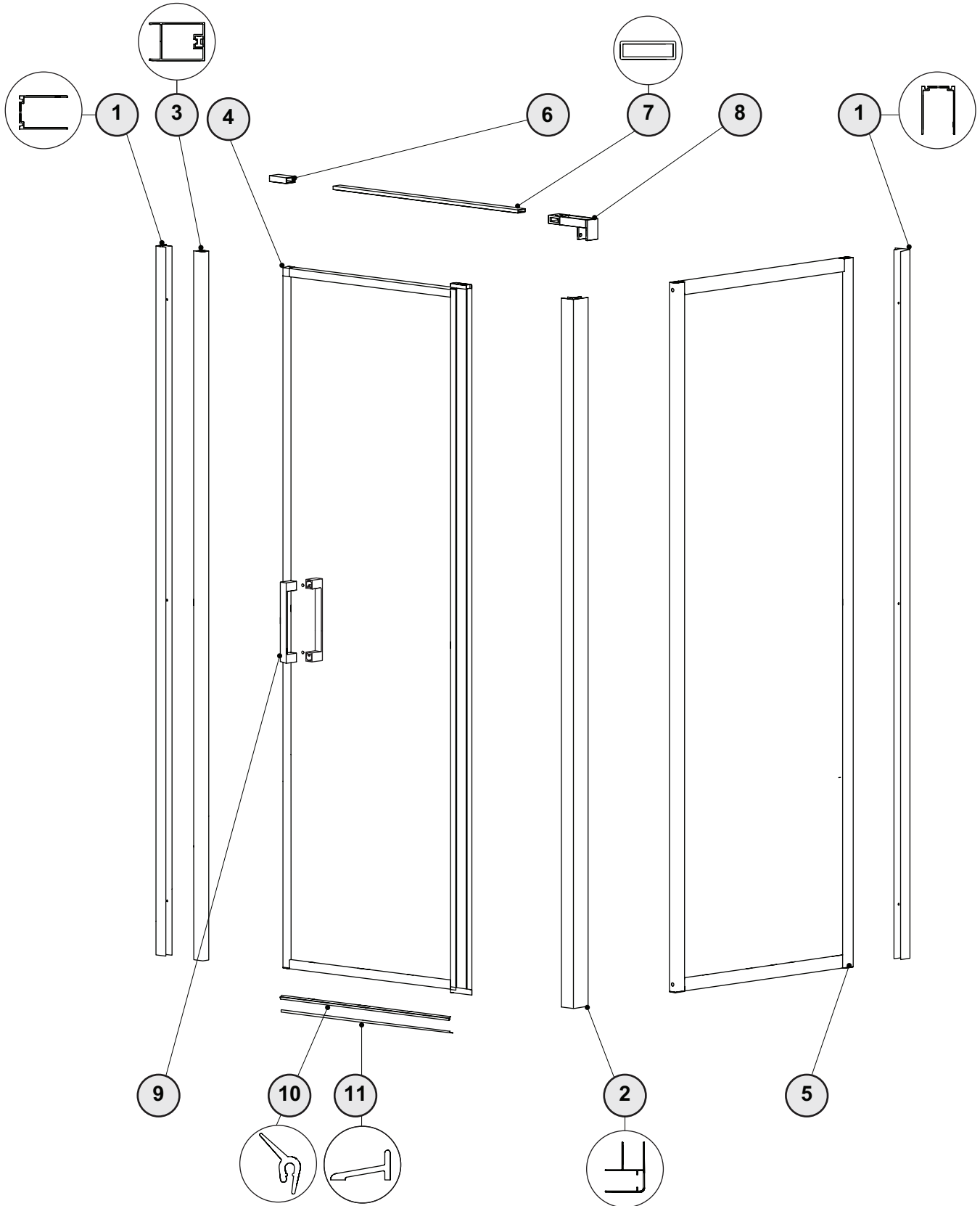

**PARTS AND HARDWARE LISTING /
LISTE DES PIÈCES ET QUINCAILLERIE**

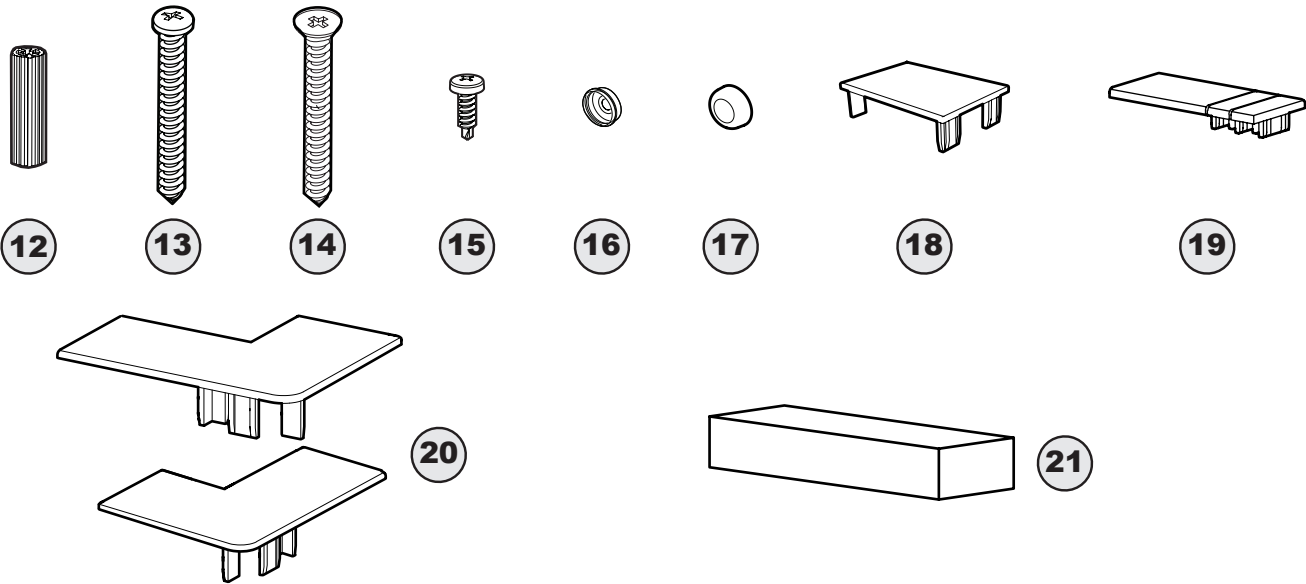

ITEM	FLEURCO CODE	PARTS AND HARDWARE / PIÈCES ET QUINCAILLERIE	QTY
1	ELE-WJAMB-XX-79	WALL JAMB / JAMBAGE	2
2	LA-CJAMB-XX-79	CORNER JAMB / JAMBAGE DU COIN	1
3	LAP-MAGEXP-XX-79	MAGNETIC EXPANDER / EXTENSEUR MAGNÉTIQUE	1
4		DOOR PANEL ASSEMBLY / ASSEMBLAGE DU PANNEAU DE PORTE	1
5		RETURN PANEL / PANNEAU DE RETOUR	1
6	LAVBRACKET-33	WALL MOUNT BRACKET / SUPPORT MURAL	1
	PJ-BRACKET-XX		
7	LAVBAR-XX-70	SUPPORT BAR / BARRE DE SUPPORT	1
8	LAV-BRACKET-S-XX	GLASS MOUNT BRACKET / SUPPORT DE VERRE	1
9		HANDLE / POIGNÉE	1
10	COEX-LA415-40-33	THRESHOLD GASKET / JOINT DU SEUIL	1
	COEX-LA415-40		
11	PLAT-THRESH-33-72	THRESHOLD / SEUIL	1
	++15405		
12		WALL PLUG / CHEVILLE	6
13		PAN HEAD SCREW / VIS À TÊTE CYLINDRIQUE	6
14		FLAT HEAD SCREW / VIS À TÊTE PLATE	1
15		PAN SELF DRILLING SCREW / VIS PAN AUTO-PERÇANTE	12
16		BACK SCREW CAP / CAPUCHON COUVRE-VIS ARRIÈRE	18
17		SCREW CAP / CAPUCHON COUVRE-VIS	18
18	LA-RP-CAP-33-79	FRAME CAP / CAPUCHON DU CADRE	1
	LA-RP-CAP-XX		
19	ELE-WJCAP-XX	WALL JAMB CAP / CAPUCHON DU JAMBAGE	2
20	LA-CJAMB-CAP-33-79	CORNER CAP / CAPUCHON DE JAMBAGE DU COIN	1 SET
	LA-CJAMB-CAP-XX		
21		SHIM / CALE	1

LEGEND / LÉGENDE
 XX = FINISH/FINI (11, 25, 33)
 ** = LENGTH / LONGUEUR (54, 60, 79, 86 ETC)
 ++ = CODE / CODE (AC, ABN)